

P-Channel Trench Power MOSFET

General Description

The CS4953 uses advanced trench technology to provide excellent $R_{DS(ON)}$, low gate charge and operation with gate voltages as low as -4.5V. This device is suitable for use as a load switch or in PWM applications.

Features

- $V_{DS} = -30V, I_D = -5.1A$
- $R_{DS(ON)} < 49m\Omega @ V_{GS} = -10V$
- $R_{DS(ON)} < 100m\Omega @ V_{GS} = -4.5V$
- High Power and current handling capability
- Lead free product is acquired
- Surface Mount Package

Application

- PWM applications
- Load switch
- Power management

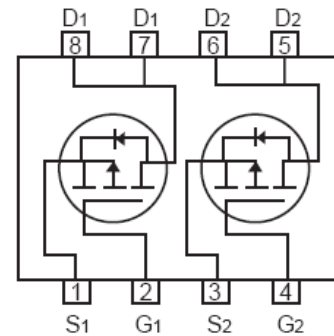

Schematic Diagram

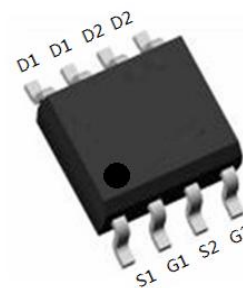

SOP-8 top view

Package Marking and Ordering Information

Device Marking	Device	Device Package	Reel Size	Tape width	Quantity
CS4953	CS4953	SOP-8	Ø330mm	12mm	2500 units

Table 1. Absolute Maximum Ratings ($T_A=25^\circ C$)

Symbol	Parameter	Value	Unit
V_{DS}	Drain-Source Voltage ($V_{GS}=0V$)	-30	V
V_{GS}	Gate-Source Voltage ($V_{DS}=0V$)	± 20	V
I_D	Drain Current-Continuous	-5.1	A
$I_{DM (pluse)}$	Drain Current-Continuous@ Current-Pulsed (Note 1)	-30	A
P_D	Maximum Power Dissipation	2.5	W
T_J, T_{STG}	Operating Junction and Storage Temperature Range	-55 To 150	$^\circ C$

Notes 1.Repetitive Rating: Pulse width limited by maximum junction temperature

Table 2. Thermal Characteristic

Symbol	Parameter	Value	Unit
$R_{\theta JA}$	Thermal Resistance, Junction-to-Ambient	50	$^\circ C/W$

Table 3. Electrical Characteristics (T_A=25°C unless otherwise noted)

Symbol	Parameter	Conditions	Min	Typ	Max	Unit
On/Off States						
B _V DSS	Drain-Source Breakdown Voltage	V _{GS} =0V I _D =-250μA	-30			V
I _{DSS}	Zero Gate Voltage Drain Current	V _{DS} =-24V, V _{GS} =0V			-1	μA
I _{GSS}	Gate-Body Leakage Current	V _{GS} =±20V, V _{DS} =0V			±100	nA
V _{GS(th)}	Gate Threshold Voltage	V _{DS} =V _{GS} , I _D =-250μA	-1	-1.6	-3	V
g _{FS}	Forward Transconductance	V _{DS} =-5V, I _D =-4.5A	4			S
R _{DS(ON)}	Drain-Source On-State Resistance	V _{GS} =-10V, I _D =-5.1A		38	49	mΩ
		V _{GS} =-4.5V, I _D =-4.2A		61	100	mΩ
Dynamic Characteristics						
C _{iss}	Input Capacitance	V _{DS} =-15V, V _{GS} =0V, f=1.0MHz		630		pF
C _{oss}	Output Capacitance			130		pF
C _{rss}	Reverse Transfer Capacitance			95		pF
Switching Times						
t _{d(on)}	Turn-on Delay Time	V _{DD} =-15V, I _D =-1A, R _L =15Ω V _{GS} =-10V, R _G =2.5Ω		11		nS
t _r	Turn-on Rise Time			5		nS
t _{d(off)}	Turn-Off Delay Time			30		nS
t _f	Turn-Off Fall Time			7		nS
Q _g	Total Gate Charge	V _{DS} =-15V, I _D =-4.9A, V _{GS} =-10V		13		nC
Q _{gs}	Gate-Source Charge			2.5		nC
Q _{gd}	Gate-Drain Charge			3		nC
Source-Drain Diode Characteristics						
I _{SD}	Source-Drain Current(Body Diode)				-1.7	A
V _{SD}	Forward on Voltage (Note 1)	V _{GS} =0V, I _S =-1.7A			-1.2	V

Notes 1. Repetitive Rating: Pulse width limited by maximum junction temperature.

Switch Time Test Circuit and Switching Waveforms:

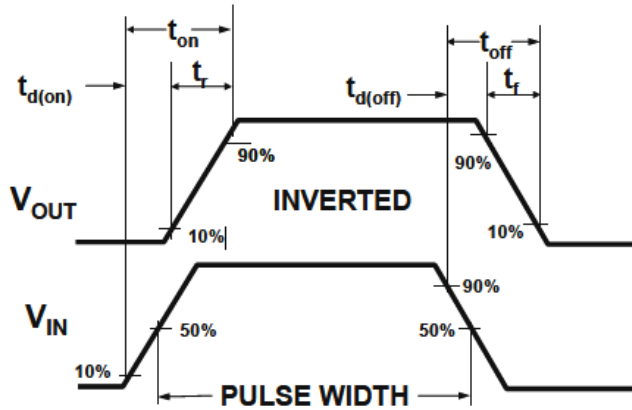
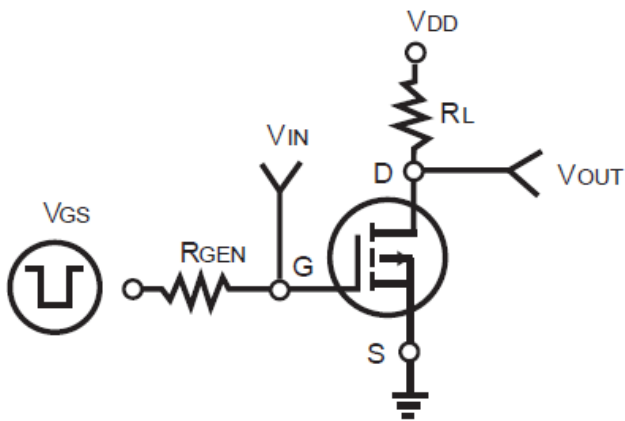

TYPICAL ELECTRICAL AND THERMAL CHARACTERISTICS (Curves)

Figure1. Power Dissipation

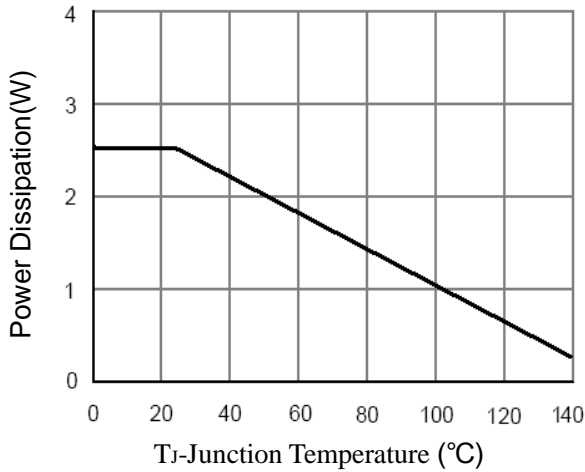

Figure2. Drain Current

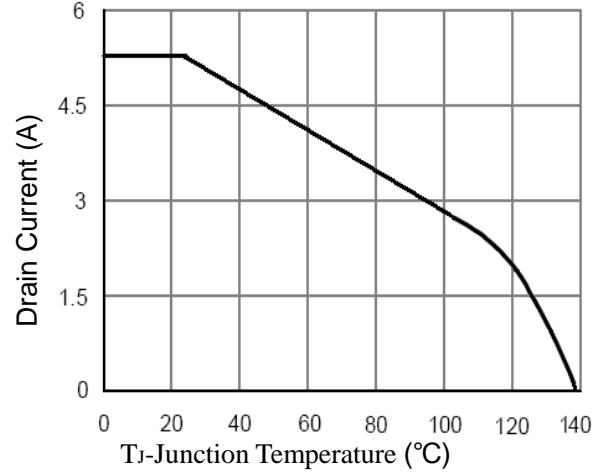

Figure3. Output Characteristics

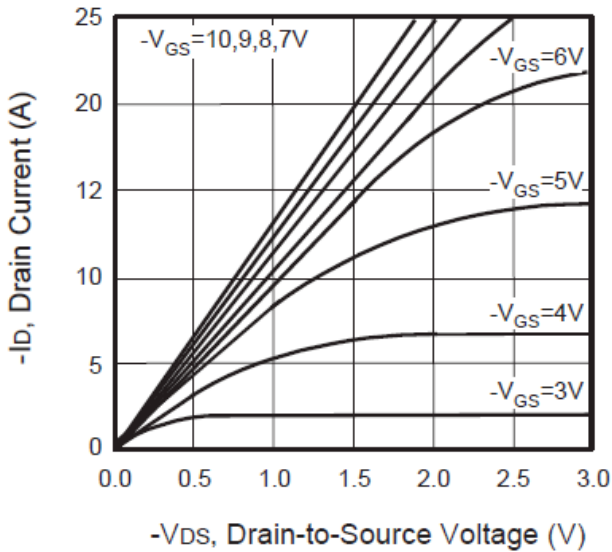

Figure4. Transfer Characteristics

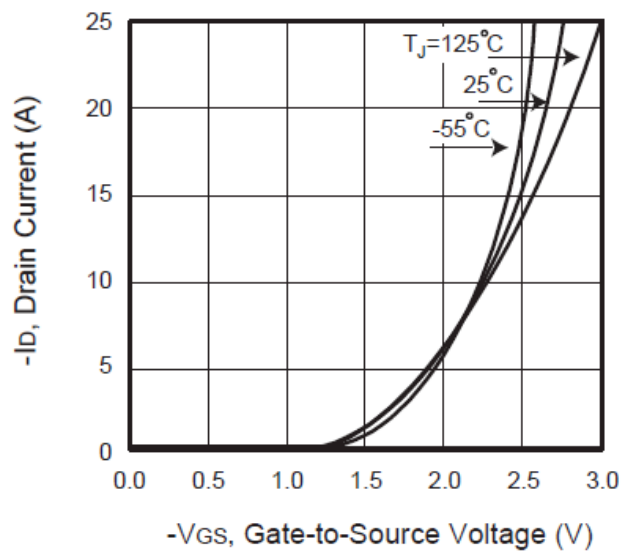

Figure5. Capacitance

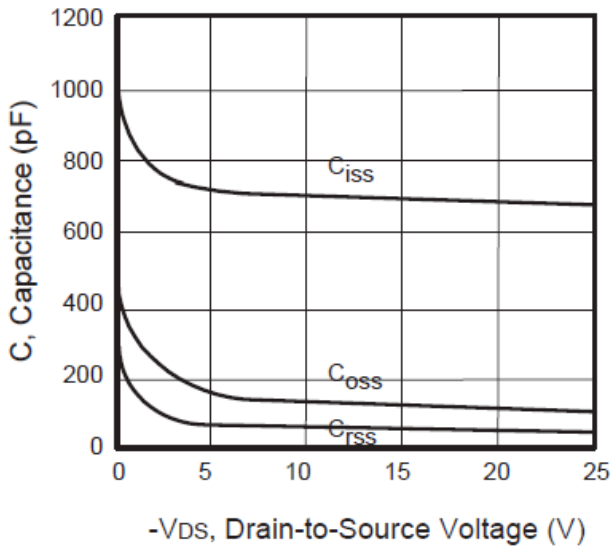

Figure6. R_{DS(ON)} vs Junction Temperature

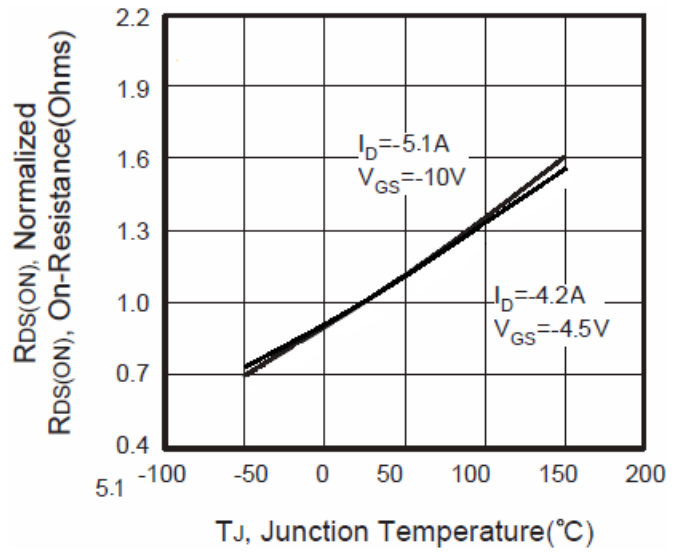

Figure7. MaxBV_{DSS} vs Junction Temperature

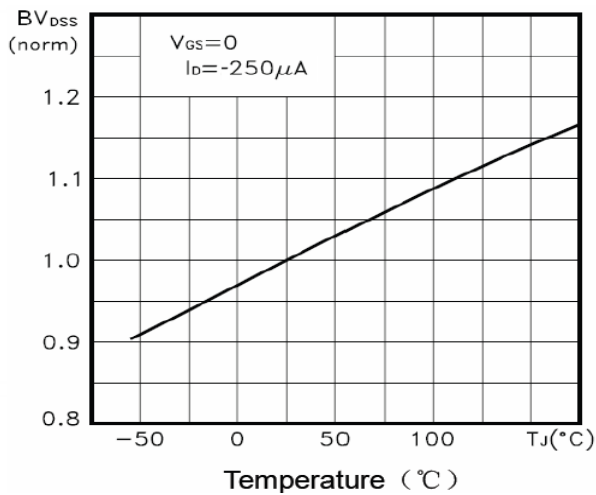

Figure8. V_{GS(th)} vs Junction Temperature

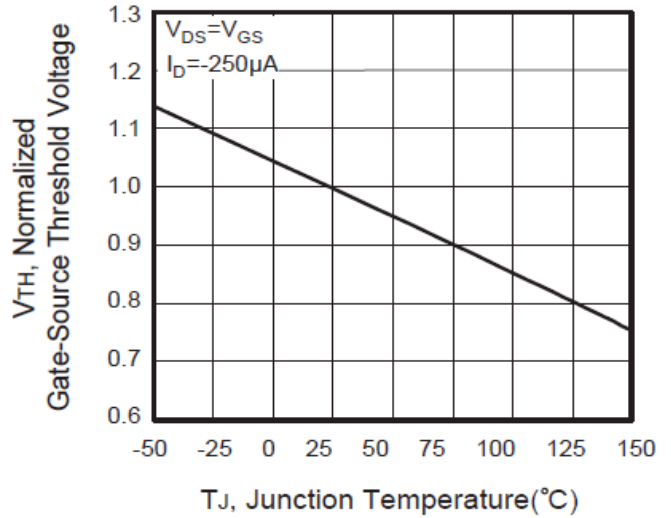

Figure9. Gate Charge Waveforms

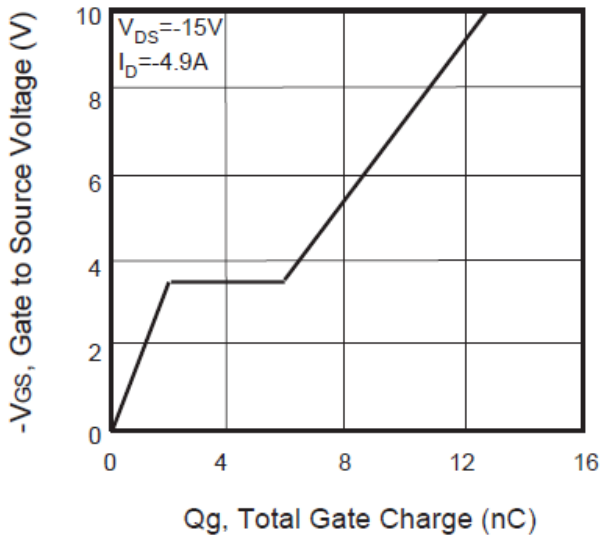

Figure10. Maximum Safe Operating Area

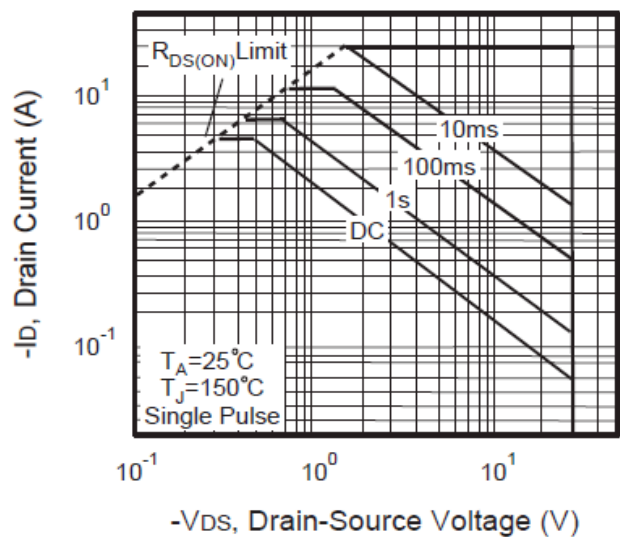
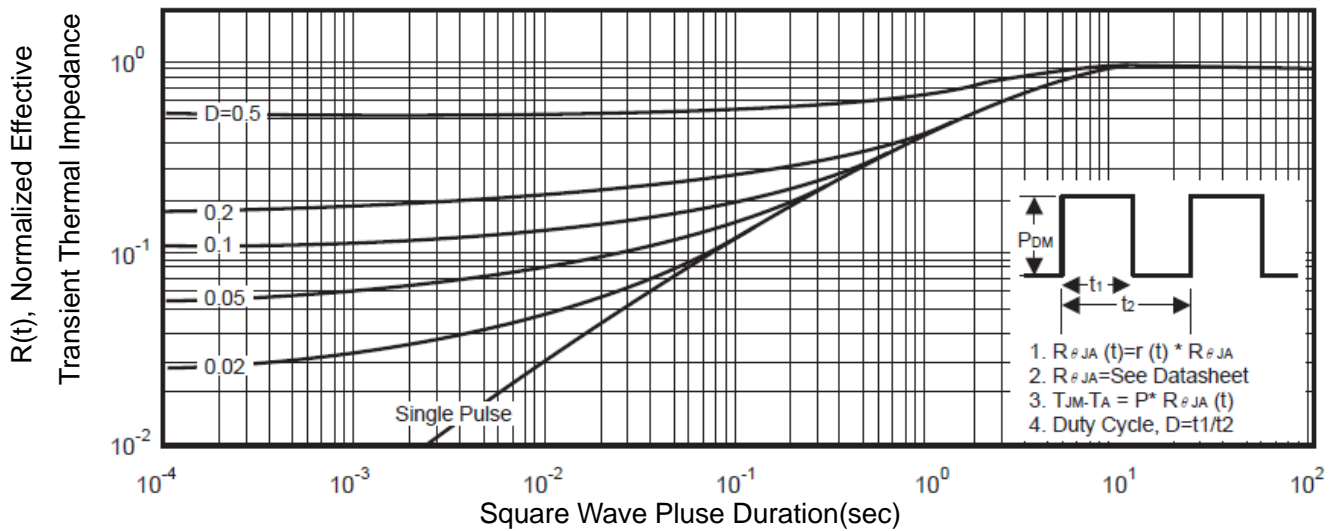
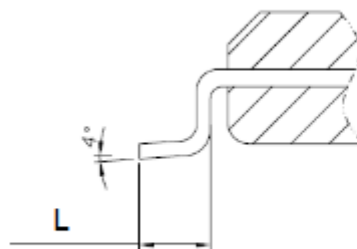
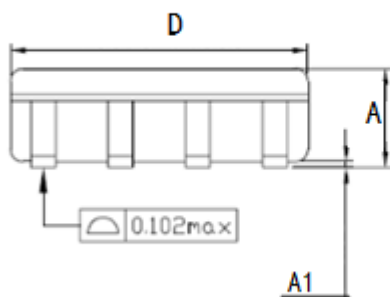
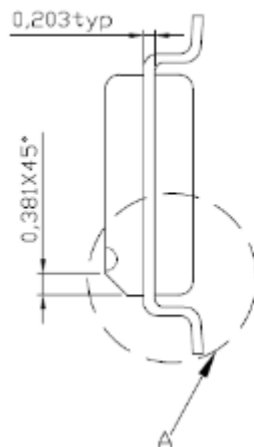
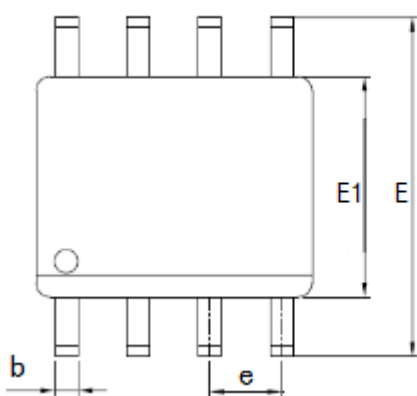

Figure11. Normalized Maximum Transient Thermal Impedance



SOP-8 Package Information



A 局部放大

COMMON DIMENSIONS			
SYMBOL	mm		
	MIN	NOM	MAX
L			
A	1.35	1.55	1.75
A1	0.1	0.15	0.2
b	0.346	0.406	0.466
D	4.8	4.89	4.98
E	5.75	6.00	6.25
E1	3.81	3.90	3.99
e	1.27TYP		
L	0.406	0.838	1.27